

Data Sheet



Article number: 204250M16200A1U

Description: E+G levelling foot
GN 42-50-M16-200-A1-U

Note: U Without nut, Hexagon socket at the top, Wrench flat at the bottom

Measures

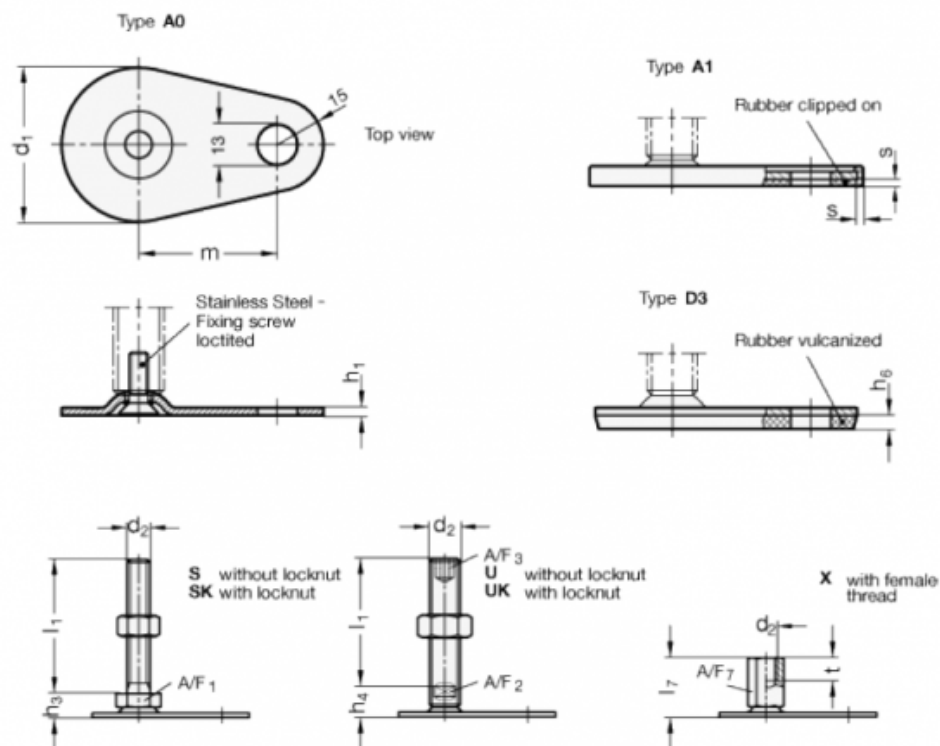

A/F2 = 12	m = 45
A/F3 = 8	s = 2
d1 = 50	
d2 = M16	
h1 = 2.5	
h4 = 17	
h6 =	
l1 = 200	